



Barra OE-20 per TOYOTA RAV4 (XA50)18> Roof bars OE-20 for TOYOTA RAV4 (XA50)18>

 IT) Gomma anti-fischio
EN) Anti-whistle rubber profile

IT) Profilo in alluminio con cava
predisposta al T-System.
EN) Aluminium profile with T-System slot.

 (IT) Serratura antifurto
(EN) Antitheft lock



Watch video

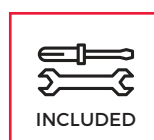

IT) Barra da tetto in alluminio esclusivamente per Toyota RAV 4 (XA50) 18>. Leggera, pratica e sicura.

EN) Aluminium roof bars exclusively for Toyota RAV 4 (XA50) 18>. Lightweight, practical and safe.







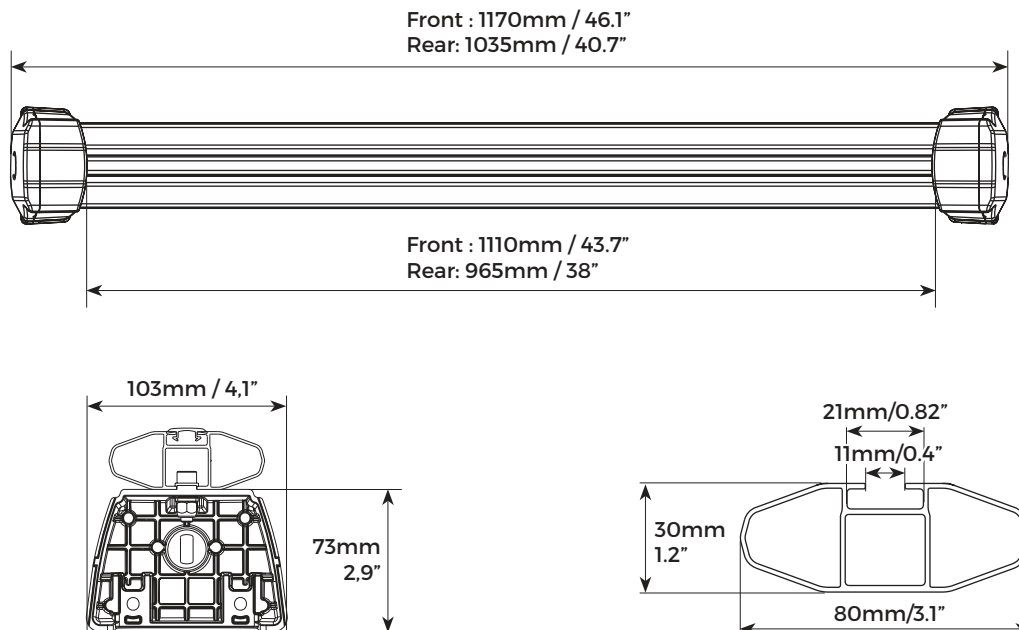

T-System



Optional Art.000110100000

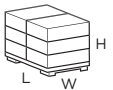

Art.	000120800000
	4,3kg / 9.4lb
Materiale Material Matière	Alluminio Aluminium Aluminio
	max 75kg/165lb
	✓

Mod.	BARRA OE TOYOTA RAV4 (XA50)18>
Art.N°	000120800000
	L x W x H : 114x22,5x13cm / 44,9x8,9x5,1"  5,2kg / 11,6lb
	L x W x H : 120x80x147cm / 47,2x31,5x57,9"  177kg / 390,2lb Pz:30
Ean-13	 8 003168 044413

F.lli Menabò s.r.l.

Via 8 Marzo 3,
 42025 Cavriago (RE), Italy
 +39-0522/942840
 info@flli-menabo.it
 www.menabocaraccessories.com